

Verso Care Grab rail

Article number: 3500152018

Product image



Technical specifications

Product group	3800
Product	Grab rail
Angle	90 °
Axle dimension a1	400 mm
Axle dimension a3	400 mm
Fixing type	single-point mounting
Fixing points	3 Piece
Diameter	34 mm
Material	polyamide
Surface	high gloss
Colour	available in nylon colours
Version	left
Loading	max. 175 kgs

Technical drawing

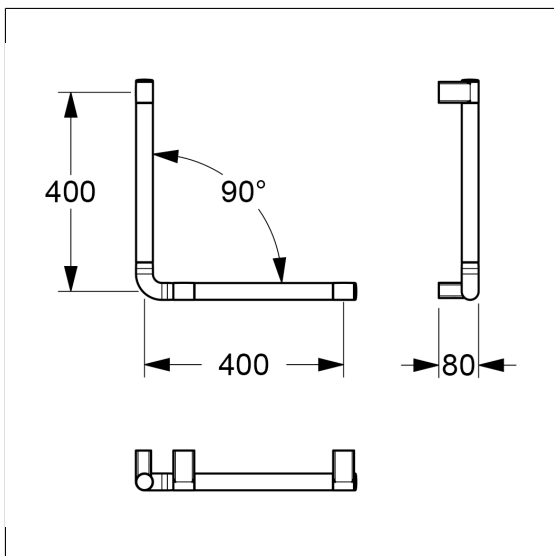

Product description

- Nylon Care - a well-trying and proven product family with a wide range of variants, three product series suiting many different requirements
- with non-corrosive steel core throughout
- with sealing elements for sealing of the drilling points according to German standard DIN 18534-1
- single-point wall attachment with 3mm tolerance compensation (= ffl 1.5mm) for an easy and safe installation,
- concealed screw fixing
- In case of lightweight partition walls a backfill made of min. 30mm hardwood is needed
- retrofittable with Toilet roll holder, optional with antibacterial protection 4300665
- produced in accordance with Regulation (EU) 2017/745 on medical devices
- CE-certified
- meets the requirements of German standard DIN 18040 and Austrian standard ÖNORM B 1600
- supplied with stainless steel hexagon head screws $\varnothing 6 \times 100$ mm according to DIN 571 and dowels

