

Nylon Care Lift-up support rail vario

Article number: 3500470022

Product image



Technical specifications

Product group	3800
Product	Lift-up support rail
System	vario, with base plate
Length	900 mm
Diameter	34 mm
Material	polyamide, base plate, made of stainless steel
Surface	high gloss
Colour	available in nylon colours
Version	left and right
Loading	max. 100 kgs

Technical drawing

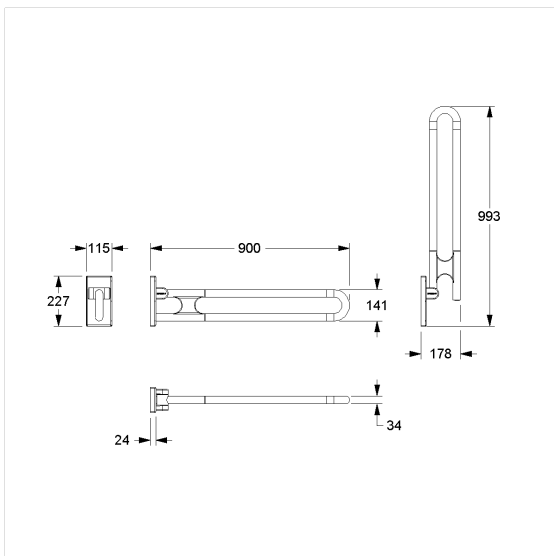

Product description

- Nylon Care - a well-trying and proven product family with a wide range of variants, three product series suiting many different requirements
- with adjustable brake
- with durable maintenance-free, friction bearings
- with non-corrosive steel core throughout
- easy installation or removing by connecting / disconnecting to base plate
- concealed screw fixing
- In case of lightweight partition walls a backfill made of min. 20mm hardwood is needed
- certified by TÜV PRODUCT SERVICE
- produced in accordance with Regulation (EU) 2017/745 on medical devices
- CE-certified
- meets the requirements of German standard DIN 18040 and Austrian standard ÖNORM B 1600
- Fixing set has to be determined according to conditions on site, is to be ordered separately



Vario

