

Care Mounting plate

Article number: 0448260018

Product image

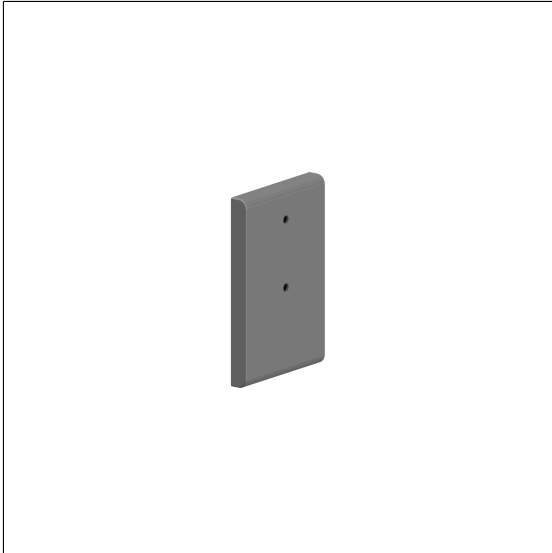

Technical specifications

Product group	2000
Product	Mounting plate
Material	polyamide
Surface	high gloss
Type of wall	in front of the wall with panels without backfill and lightweight partition walls
Colour	available in nylon colours

Technical drawing

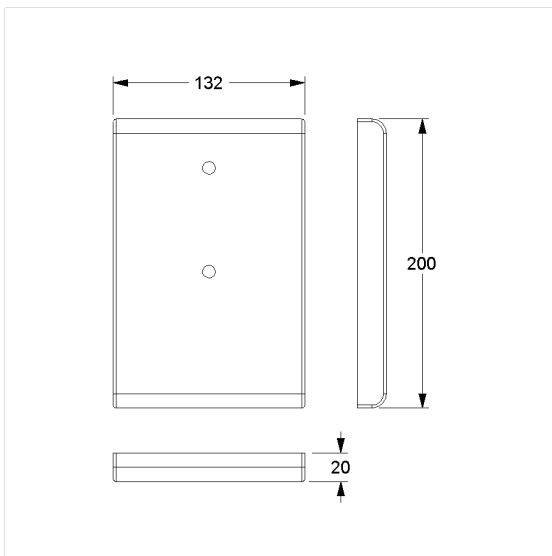

Product description

- Nylon Care - a well-tried and proven product family with a wide range of variants, three product series suiting many different requirements
- suitable for:
 - Inox Care lift-up shower seats
 - Nylon Care 300 and Nylon Care 400 lift-up shower seats
 - Nylon Care 300 shower guard rail
- concealed screw fixing
- with non-corrosive steel core throughout
- Supplied with mounting material for fixing the hinge to the mounting plate
- The mounting set for fixing the mounting plate to the wall is not included in the scope of delivery and must be determined according to the wall condition and ordered separately

