

NORMBAU

PASSION FOR CARE

Inox Care®

- DE Montage- und
Gebrauchsanleitung
- EN Fixing instruction and
directions for use
- FR Instructions de montage et
d'utilisation
- NL Montage- en
gebruiksaanwijzing



2291 611



2291 612



2291 605



2291 606



2291 645



2291 635



2291 651

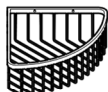

2291 641

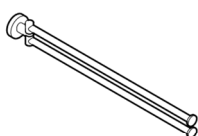

2291 622

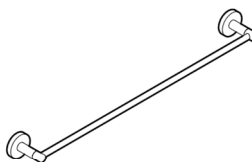

2291 621

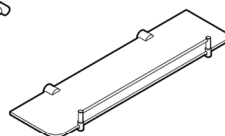

2291 646



2291 613

2291 614

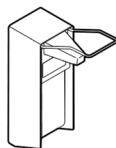

2291 631

2291 632



2291 627

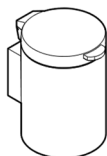

2291 601

2291 603

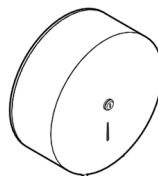

2291 626

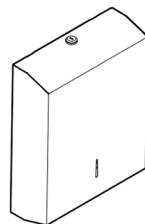

2291 625



Weitere Informationen
Further information
Plus d'informations
Meer informatie
extranet.normbau.de

1

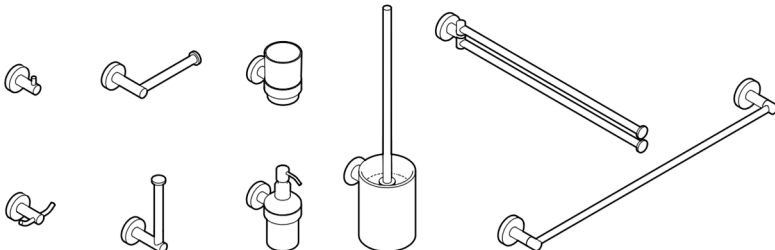

1.1 2,5

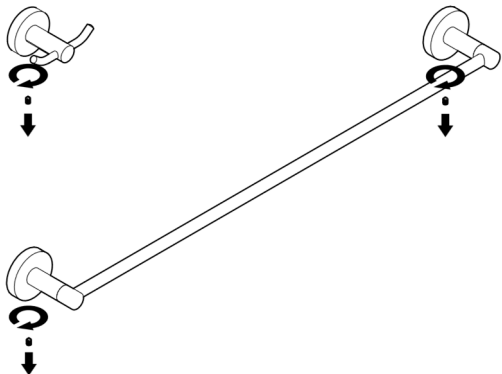

1.2

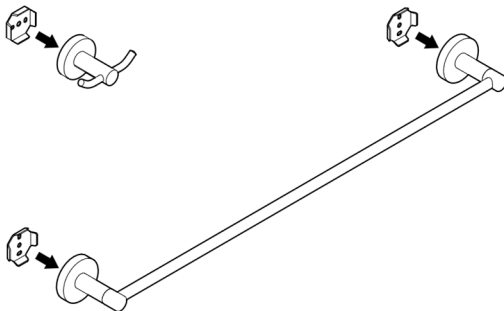

1.3

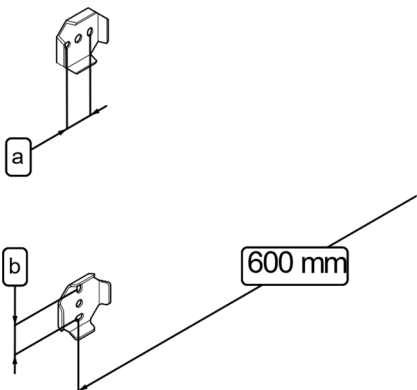

| | a | b |
|-----------------|-------|-------|
| 2291 605 | 21 mm | |
| 2291 606 | 21 mm | |
| 2291 611 | 21 mm | |
| 2291 612 | 21 mm | |
| 2291 621 | | 27 mm |
| 2291 622 | | 20 mm |
| 2291 635 | 21 mm | |
| 2291 645 | 21 mm | |
| 2291 651 | | 38 mm |

1.4



Ø6x40



PZ2



1.5

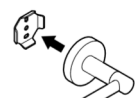
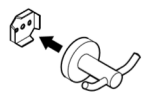

1.6



2,5



2



Ø6x40

PZ2

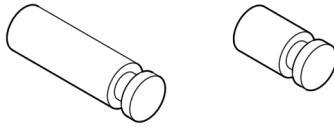

2.1

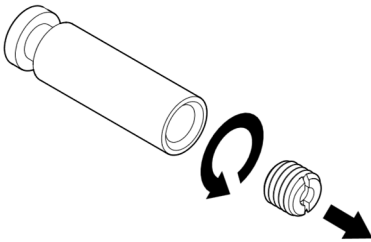

2.2



Ø6x40



PZ2

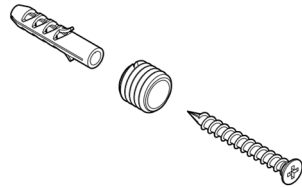

2.3

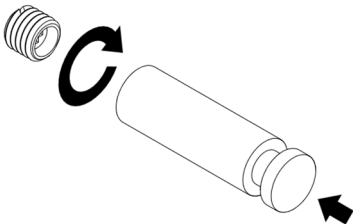

3

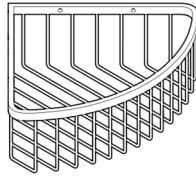

3.1

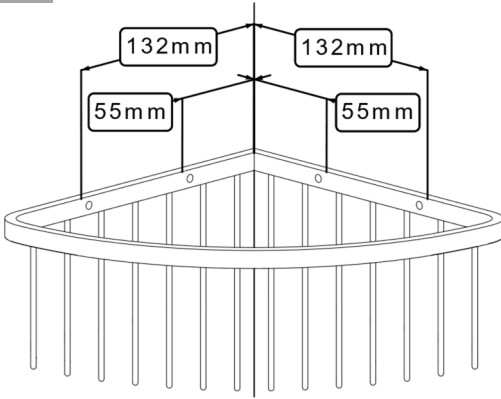

3.2



Ø6x40 | PZ2

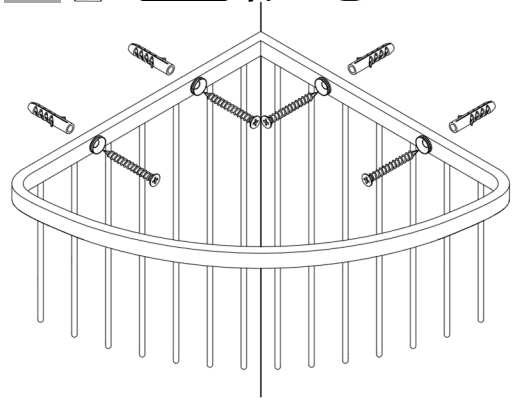

3.3

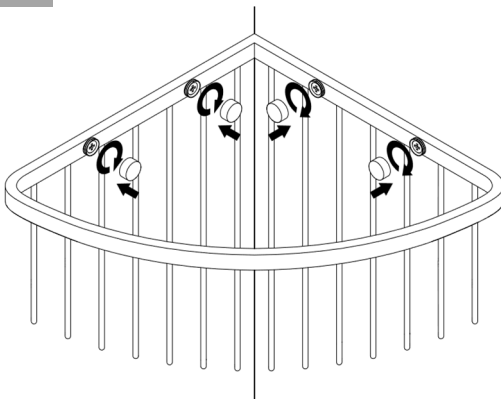

4

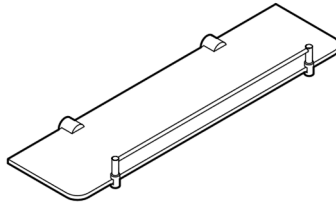

4.1

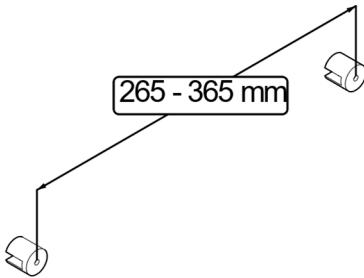

4.2



Ø6x40 |  PZ2



4.3

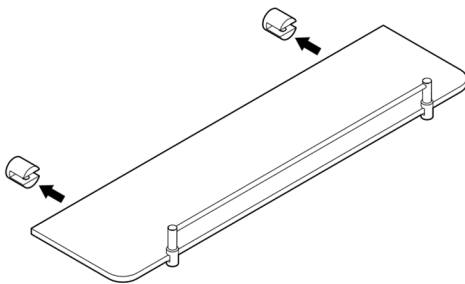

4.4

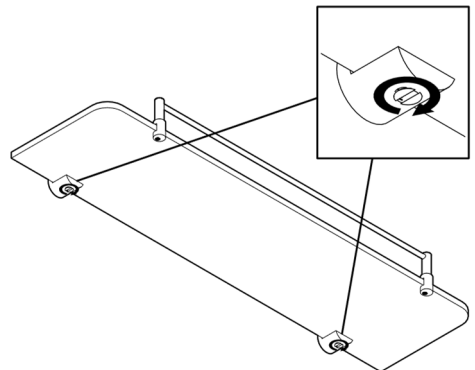

5

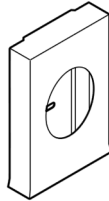
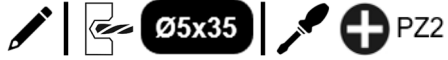

5.1

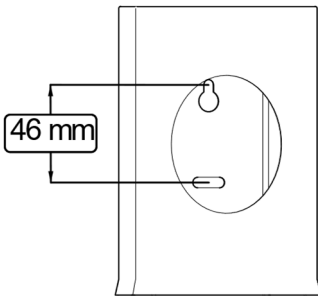

5.2



Ø5x35



PZ2

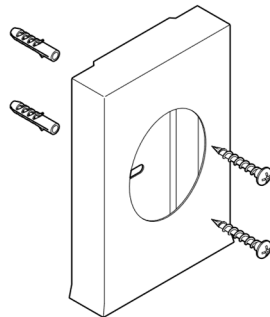

6

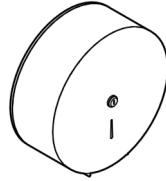
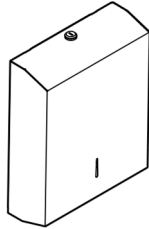

6.1

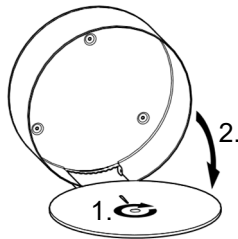
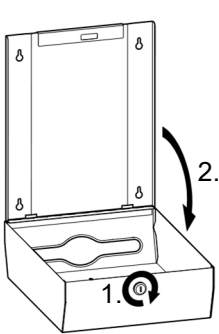

6.2

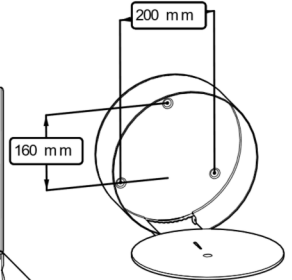
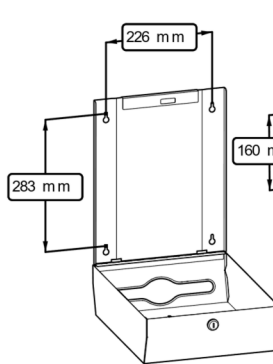

6.3



Ø6x40



PZ2

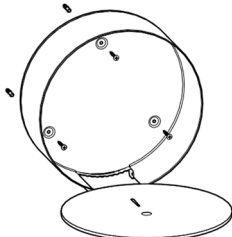
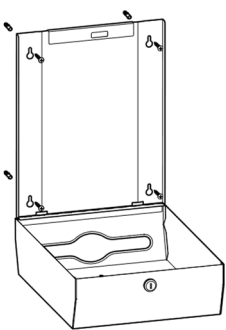

6.4

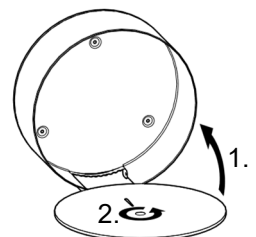
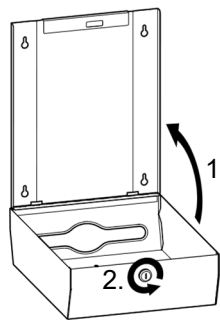

7

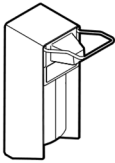

2291 631 019

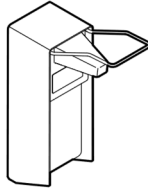

2291 632 019

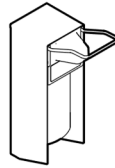

2291 631 008
2291 631 009

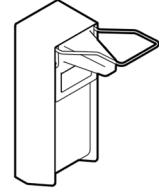

2291 632 008
2291 632 009

7.1.1

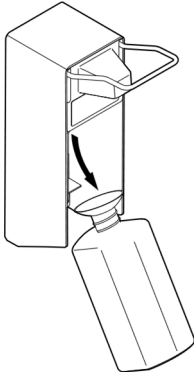

7.1.2

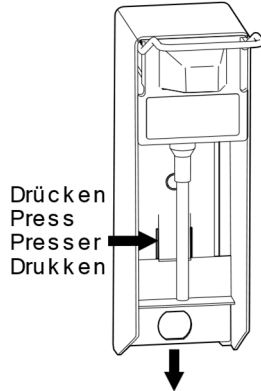

7.1.3

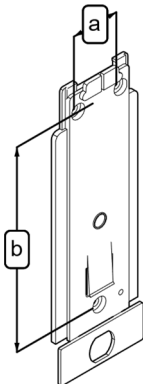

| | a | b |
|--------------|-------|--------|
| 2291 631 019 | 40 mm | 167 mm |
| 2291 632 019 | 40 mm | 202 mm |

7.1.4

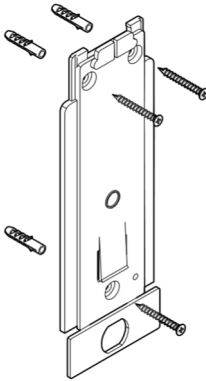

7.1.5

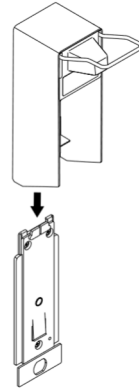

7.1.6

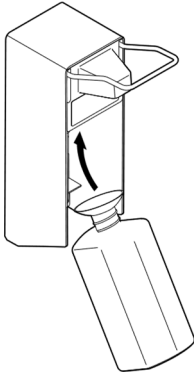

7.2.1

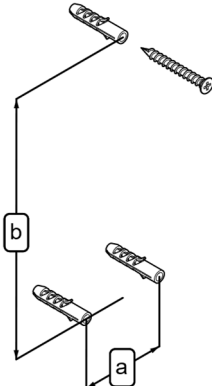

| | a | b |
|---------------------|-------|--------|
| 2291 631 008 | 46 mm | 136 mm |
| 2291 631 009 | 46 mm | 136 mm |
| 2291 632 008 | 52 mm | 196 mm |
| 2291 632 009 | 52 mm | 196 mm |

7.2.2

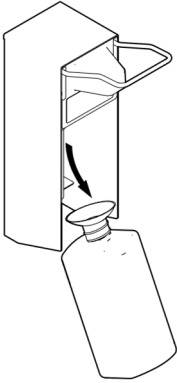

7.2.3

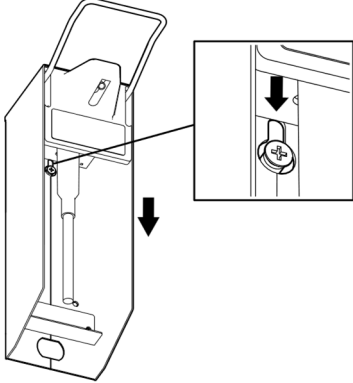

7.2.4

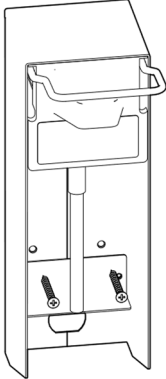

7.2.5



8

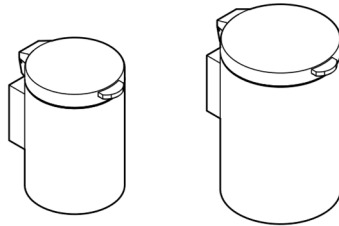

8.1

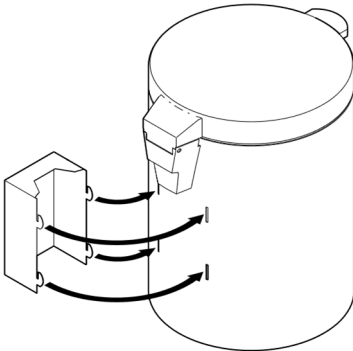

8.2

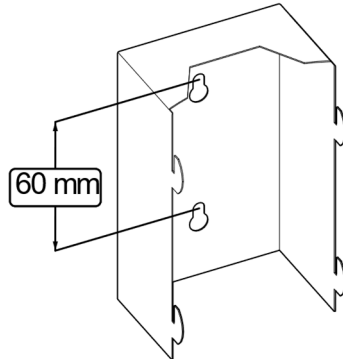

8.3

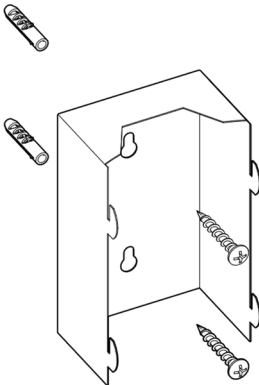

8.4

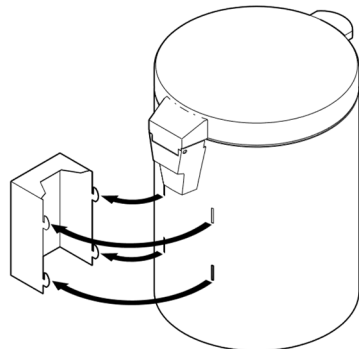

DE

Pflege- und Reinigungshinweise

Nur mit einem feuchten Tuch oder Spülmittel reinigen. Keine Chemikalien, Alkohol oder Essigreiniger verwenden.

Haftungsausschluss

Die Firma NORMBAU übernimmt keine Haftung für Personen- oder Sachschäden, die durch unsachgemäße Montage, Anwendung oder Reinigung, insbesondere unter Missachtung der in dieser Anleitung aufgeführten Warn- und Sicherheitshinweise, entstehen oder entstanden sind.

Garantie

Die Gewährleistung beträgt entsprechend der derzeitigen Regelung 2 Jahre. Bei Einhaltung der vorgesehenen Einsatzbedingungen sowie der Wartungs- und Reinigungsrichtlinien beträgt die erwartete Lebensdauer mindestens 10 Jahre. Das Produkt wurde auf Grundlage dieser Lebensdauer getestet und validiert.

Wünschen Sie weitere Informationen zu den Produkten, dann besuchen Sie uns unter www.normbau.de oder kontaktieren Sie uns über den Kundenservice +49 (0)7843 704 0.

Für eine vergrößerte Ansicht finden Sie diese Montageanleitung unter Eingabe der Artikelnummer auf der Homepage.

FR

Instructions d'entretien et de nettoyage

Nettoyer uniquement à l'aide d'un chiffon humide ou de liquide vaisselle. Ne pas utiliser de produits chimiques, alcool ou vinaigre blanc.

Exclusion de garantie

NORMBAU décline toute responsabilité en cas de dommages corporels ou matériels causés par un montage, une utilisation ou un nettoyage incorrect, notamment par le non-respect des avertissements et des consignes de sécurité figurant dans ses instructions.

Garantie

Selon la réglementation en vigueur, la garantie est de 2 ans. Si les conditions d'utilisation prévues ainsi que les directives d'entretien et de nettoyage sont respectées, la durée de vie attendue est d'au moins 10 ans.

Le produit a été testé et validé sur la base de cette durée de vie.

Vous souhaitez des informations supplémentaires sur nos produits, visitez notre site www.normbau.de ou contactez notre service relations clients au +49 (0)7843 704 0.

Les instructions de montage peuvent également être téléchargées sur le site Web avec le code article pour une vue agrandie.

NORMBAU GmbH

Schwarzwaldstraße 15

77871 Renchen Germany

E-Mail: normbau@allegion.com

Internet: www.normbau.de

2025-02-17 / 8214 105 / A

EN

Care and cleaning instructions

Only use a damp cloth or washing-up liquid to clean. Do not use any chemical, alcohol or vinegar-based cleaners.

Disclaimer of liability

NORMBAU assumes no liability for personal injury or property damage that arises or has arisen as a result of improper assembly, use or cleaning, in particular in disregard of the warning and safety instructions listed in these instructions.

Warranty

The warranty period is 2 years in accordance with current regulations. If the intended operating conditions and the maintenance and cleaning guidelines are respected, the expected service life is at least 10 years. The product has been tested and validated based on this service life.

If you would like to get more information about the products, visit us at www.normbau.de or contact us via customer service +49 (0) 7843 704 0.

For an enlarged view, you can find these assembly instructions by entering the article number on the homepage.

NL

Onderhouds- en reinigingsinstructies

Reinig uitsluitend met vochtige doek, of afwasmiddel. Gebruik geen chemicaliën, alcohol, of schoonmaakazijn.

Disclaimer

De firma NORMBAU is niet verantwoordelijk voor persoonlijk letsel of materiele schade veroorzaakt door onjuiste montage, gebruik of reiniging. In het bijzonder als de veiligheidsaanwijzingen niet in acht zijn genomen.

Garantie

Volgens de huidige regelgeving bedraagt de garantie 2 jaar. Als de beoogde bedrijfsomstandigheden en de onderhouds- en reinigingsrichtlijnen worden nageleefd, bedraagt de verwachte levensduur minimaal 10 jaar.

Op basis van deze levensduur is het product getest en gevalideerd.

Indien u meer informatie wilt over onze producten, bezoek dan onze website, www.normbau.de of neem contact op met onze klantenservice + 49 7843 704 0.

De Montage instructies kunnen ook worden gedownload van de website onder het artikelnummer voor een grotere weergave.



ALLEGION®