

Care Solutions · Nylon Care 300

Nylon Care 300 Hanging seat

Article number: 0300773067

Product image



Technical specifications

Product group	0700
Product	Hanging seat
Length	480 mm
Height	450 mm
Width	515 mm
Material	polyamide
Surface	high gloss
Colour	available in nylon colours
Loading	max. 175 kgs

Technical drawing

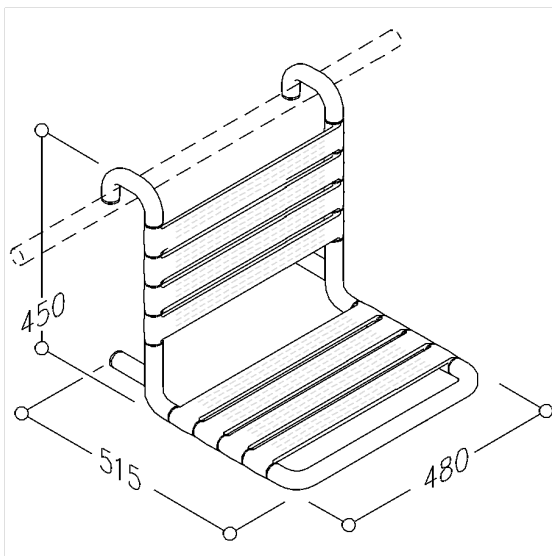

Product description

- Nylon Care - a well-trying and proven product family with a wide range of variants, three product series suiting many different requirements
- for hanging in Cavere Care Shower handrails
- with non-corrosive steel core throughout
- with non-slip seat and backrest by textured surface
- for top edge of shower handrail 850mm the seat height corresponds 470 mm (DIN18040 und ÖNORM B1600)

