

Care Solutions · Nylon Care 400

Nylon Care 400 Lift-up shower seat,
with floor support

Article number: 0841611014

Product image



Technical specifications

Product group	2000
Product	Lift-up shower seat, with floor support
Length	480 mm
Height	480 mm
Width	410 mm
Material	polyamide
Surface	high-gloss with textured surface
Colour	available in nylon colours
Loading	max. 175 kgs

Technical drawing

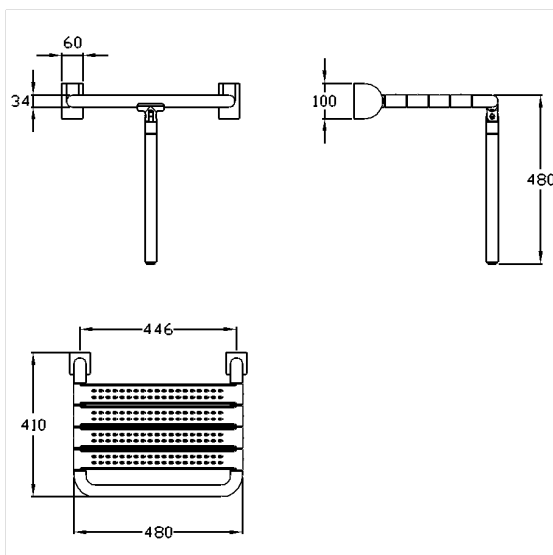

Product description

- Nylon Care - a well-trying and proven product family with a wide range of variants, three product series suiting many different requirements
- Pad with non-corrosive steel core throughout
- steel reinforced hinges
- with adjustable brake
- locked in place in vertical position
- Floor support with adjustable non-slip floor contact
- Floor support serves as a support in case of insufficient wall condition, thus the resulting forces on the wall fixing can be reduced
- concealed screw fixing
- In case of lightweight partition walls a backfill made of min. 20mm hardwood is needed
- Fixing set has to be determined according to conditions on site, is to be ordered separately

