

Care Solutions · Cavere Care

Cavere Care Shower handrail,
with movable shower handrail

Article number: 7486075095

Product image



Technical specifications

Product group	7000
Product	Shower handrail, with movable shower handrail
Axle dimension a1	750 mm
Axle dimension a2	750 mm
Axle dimension a3	1200 mm
Fixing type	L-support
Fixing points	5 Piece
Material	aluminium
Surface	scratch-resistant powder coating with antibacterial protection (except 091 Carbon black)
Colour	available in Cavere colours
Version	left
Loading	max. 150 kgs

Technical drawing

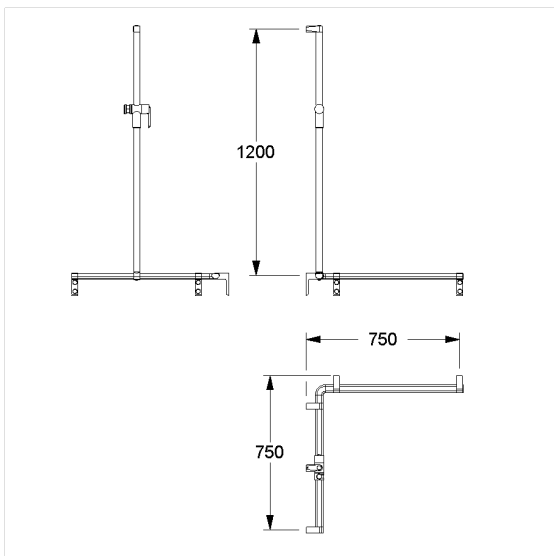

Product description

- Cavere Care as an award-winning product family with excellent design for all requirements
- ergonomic by trigonometric handle contour
- Shower head holder with easy adjustment to any height and angle, self-adjusting clamp maintenance-free
- side-mounted operating lever for one-handed operation without turning,
- Shower head holder with plastic insert, suitable for various hand shower types
- In case of lightweight partition walls a backfill made of min. 20mm hardwood is needed
- CE-certified
- meets the requirements of German standard DIN 18040 and Austrian standard ÖNORM B 1600
- supplied with stainless steel Torx screw $s\varnothing 6 \times 70$ mm and plugs



Antibac

