

Care Solutions · Nylon Care 300

Nylon Care 300 Lift-up support rail,
with toilet roll holder and floor support

Article number: 0300438022

Product image



Technical specifications

Product group	0700
Product	Lift-up support rail, with toilet roll holder and floor support
Length	900 mm
Fixing height	800 mm
Diameter	34 mm
Material	polyamide
Surface	high gloss
Colour	available in nylon colours
Version	left and right
Loading	max. 100 kgs

Technical drawing

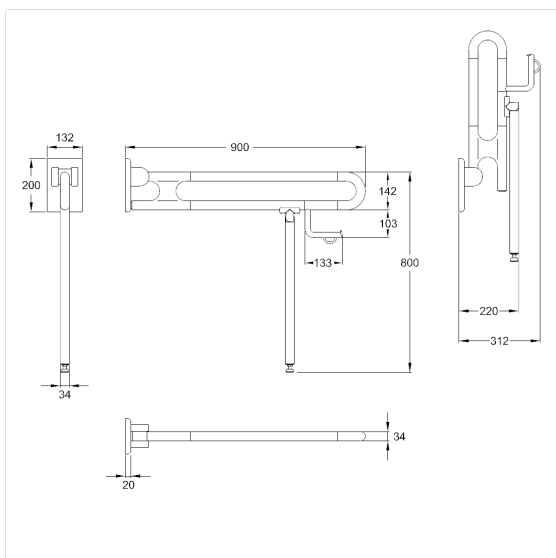

Product description

- Nylon Care - a well-trying and proven product family with a wide range of variants, three product series suiting many different requirements
- with adjustable brake
- with durable maintenance-free, friction bearings
- with non-corrosive steel core throughout
- floor support with non-slip floor contact
- with paper roll holder with maintenance free roll brake
- with steel reinforced mounting plate for three-point fixing and Nylon cover
- Floor support serves as a support in case of insufficient wall condition, thus the resulting forces on the wall fixing can be reduced
- concealed screw fixing
- In case of lightweight partition walls a backfill made of min. 20mm hardwood is needed
- certified by TÜV PRODUCT SERVICE
- load capacity: max. 100kgs according to ISO17966:2016, statically tested up to 150kgs
- produced in accordance with Regulation (EU) 2017/745 on medical devices
- CE-certified
- meets the requirements of German standard DIN 18040 and Austrian standard ÖNORM B 1600
- Fixing set has to be determined according to conditions on site, is to be ordered separately

