

Care Solutions · Modular Seating Solution

Ascento Hanging seat,
with backrest and armrests

Article number: 8750028151

Product image



Technical specifications

Product group	8700
Product	Hanging seat, with backrest and armrests
Compatible for	for Inox Care and Nylon Care
Length	584 mm
Height	574 mm
Width	640 mm
Material	Polypropylene, support bracket and suspension device made of aluminium
Surface	matt
Colour	available in Ascento colours
Loading	max. 150 kgs

Technical drawing

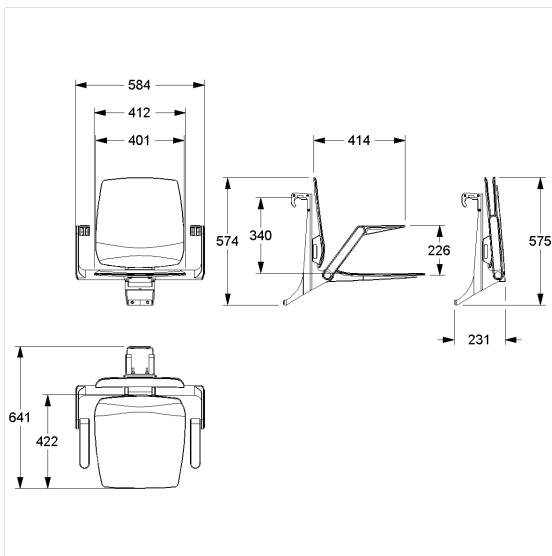

Product description

- Ascento as Modular Seating Solution, expandible and combinable
- for hanging in Inox Care and Nylon Care Shower handrails
- ergonomic formed seat and backrest with rounded outer edges
- with adjustable brake
- locked in place in vertical position
- for top edge of shower handrail 790-800mm
- concealed screw fixing

