

Nylon Care Lift-up support rail vario,
with toilet roll holder and floor support

Article number: 3500930016

Product image



Technical specifications

Product group	3800
Product	Lift-up support rail, with toilet roll holder and floor support
System	vario, with base plate
Length	725 mm
Fixing height	800 mm
Diameter	34 mm
Material	polyamide, base plate, made of stainless steel
Surface	high gloss
Colour	available in nylon colours
Version	left and right
Loading	max. 100 kgs

Technical drawing

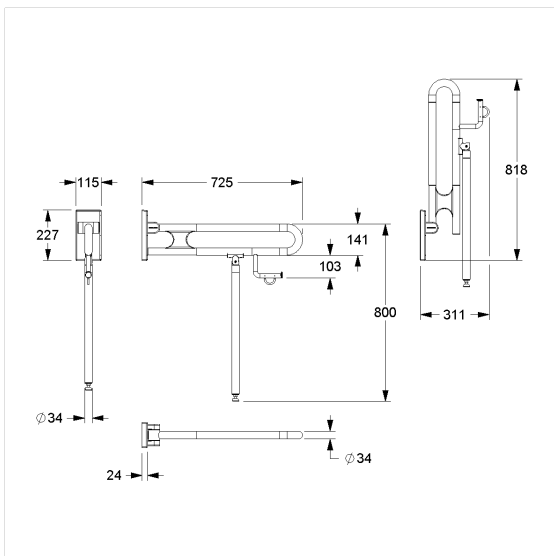

Product description

- Nylon Care - a well-trying and proven product family with a wide range of variants, three product series suiting many different requirements
- with adjustable brake
- with durable maintenance-free, friction bearings
- with non-corrosive steel core throughout
- floor support with non-slip floor contact
- with paper roll holder with maintenance free roll brake
- easy installation or removing by connecting / disconnecting to base plate
- Floor support serves as a support in case of insufficient wall condition, thus the resulting forces on the wall fixing can be reduced
- concealed screw fixing
- In case of lightweight partition walls a backfill made of min. 20mm hardwood is needed
- certified by TÜV PRODUCT SERVICE
- load capacity: max. 100kgs according to ISO17966:2016, statically tested up to 150kgs
- produced in accordance with Regulation (EU) 2017/745 on medical devices
- CE-certified
- meets the requirements of German standard DIN 18040 and Austrian standard ÖNORM B 1600
- Fixing set has to be determined according to conditions on site, is to be ordered separately



Vario



014 015 016 018 019 020 022 028 035 067