

## Care Solutions · Inox Care

Inox Care Backrest

Article number: 2050525009

### Product image

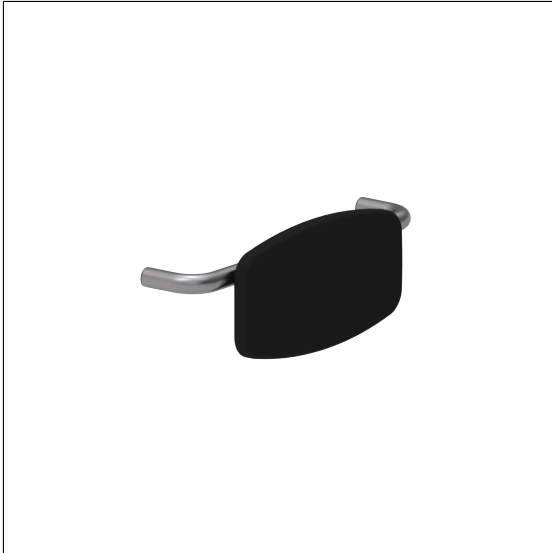

### Technical specifications

Product group	5500
Product	Backrest
Length	520 mm
Width	150 mm
Height	150 mm
Diameter	32 mm
Material	stainless steel, material No. 1.4301 (A2, AISI 304), padded made of PUR integral foam
Surface	brushed finish
Colour	Stainless steel (009), padded, colour black

### Technical drawing

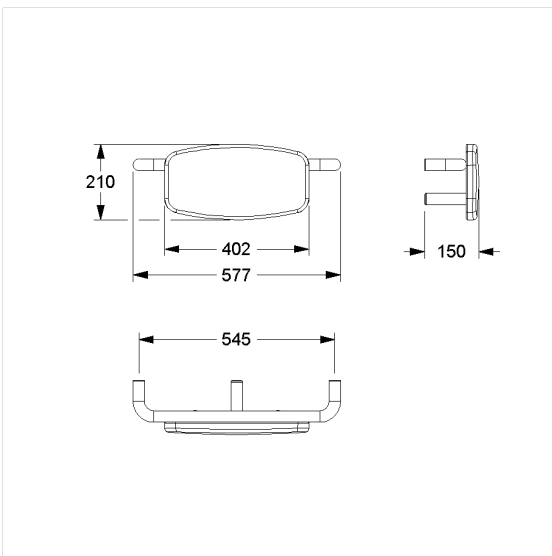

### Product description

- Inox Care as a robust and timeless classic with bacteriostatic properties
- concealed screw fixing
- supplied with suitable fixing material for front-wall installation



009