

Care Solutions · Nylon Care 400

Nylon Care 400 Hanging seat

Article number: 0844710019

Product image



Technical specifications

Product group	2000
Product	Hanging seat
Length	410 mm
Height	439 mm
Width	564 mm
Material	polyamide, padded made of PUR integral foam
Surface	high gloss
Colour	available in nylon colours, padded, colour black
Loading	max. 175 kgs

Technical drawing

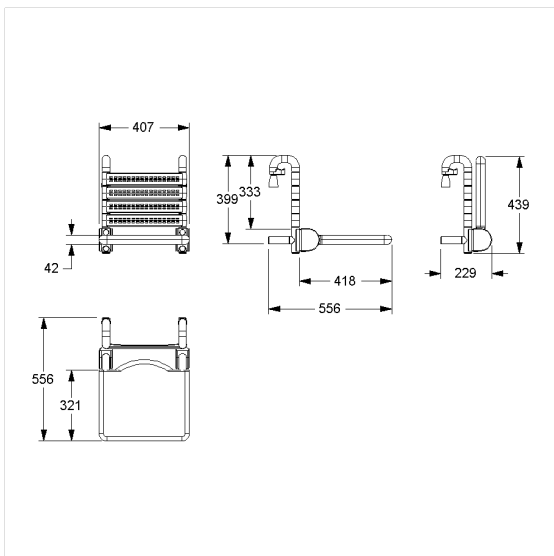

Product description

- Nylon Care - a well-trying and proven product family with a wide range of variants, three product series suiting many different requirements
- for hanging in Cavere Care Shower handrails
- for hanging in Inox Care and Nylon Care Shower handrails
- Pad with non-corrosive metal core throughout,
- with adjustable brake
- locked in place in vertical position
- with non-corrosive steel core throughout
- steel reinforced hinges
- with adjustable brake
- locked in place in vertical position
- for top edge of shower handrail 850mm the seat height corresponds 460 mm (DIN18040 und ÖNORM B1600)
- retrofittable with armrest 7843100

