

Care Solutions · Nylon Care 400

Nylon Care 400 Hanging seat

Article number: 0847914095

Product image



Technical specifications

Product group	2000
Product	Hanging seat
Length	450 mm
Height	406 mm
Width	563 mm
Material	aluminium, padded made of PUR integral foam
Surface	scratch-resistant powder coating with antibacterial protection
Colour	available in White (019), Cavere Metallic anthracite (095) and Cavere Metallic silver (096)
Loading	max. 175 kgs

Technical drawing

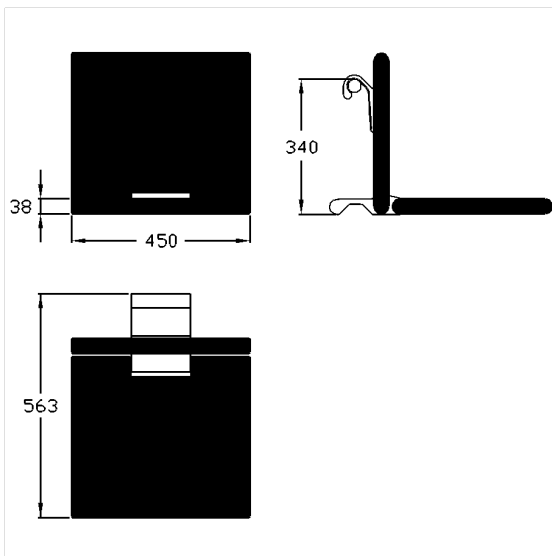

Product description

- Nylon Care - a well-trying and proven product family with a wide range of variants, three product series suiting many different requirements
- for hanging in Cavere Care Shower handrails
- for hanging in Inox Care and Nylon Care Shower handrails
- Pad with non-corrosive metal core throughout,
- with adjustable brake
- locked in place in vertical position
- with non-corrosive steel core throughout
- steel reinforced hinges
- with adjustable brake
- locked in place in vertical position
- for top edge of shower handrail 770-800mm
- for top edge of shower handrail 850mm the seat height corresponds 460 mm (DIN18040 und ÖNORM B1600)
- retrofittable with armrest 7843100

