

Care Solutions · Inox Partition solutions

Inox Partition Door Lock

Article number: 2290120009

Product image



Technical specifications

Product group	6600
Product	Partition Door Lock
Short name	NT.TWR 84
Door thickness	13 - 18 mm
Length	80 mm
Width	75 mm
Height	55 mm
Material	stainless steel, material No. 1.4401 (A4, AISI 316)
Surface	brushed finish
Colour	Stainless steel (009)

Technical drawing

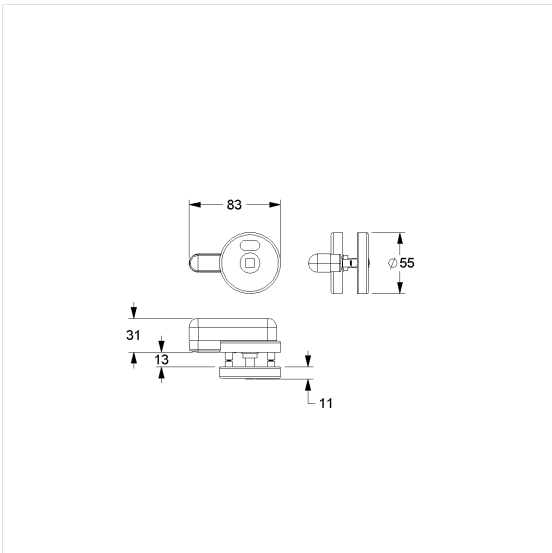

Product description

- Design partition solutions for doors and partitions made of HPL board material
- Suitable for rebated, unrebated and unrebated overlapping doors, depending on the design
- Thumbturn 360° turnable, with 90° snap-in locking
- Supplied with 2 M4 countersunk screws
- Available for other door thicknesses on request



009