

Care Solutions · Nylon Care Accessories

Nylon Care Tumbler holder

Article number: 0925100067

Product image



Technical specifications

Product group	0200
Product	Tumbler holder
Length	125 mm
Width	116 mm
Height	39 mm
Material	polyamide
Surface	high gloss
Colour	available in nylon colours

Technical drawing

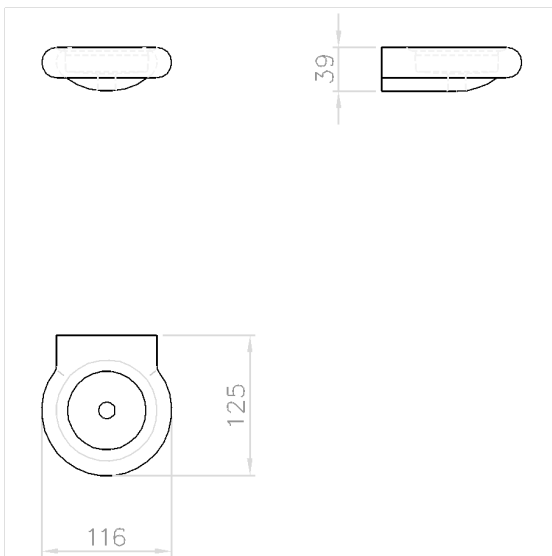

Product description

- Nylon Care - a well-trying and proven product family with a wide range of variants, three product series suiting many different requirements
- Removable for cleaning
- concealed screw fixing
- for wall mounting
- supplied with fixing material

