

Care Solutions

Care Shower box,
with clamping device

Article number: 0925350014

Product image

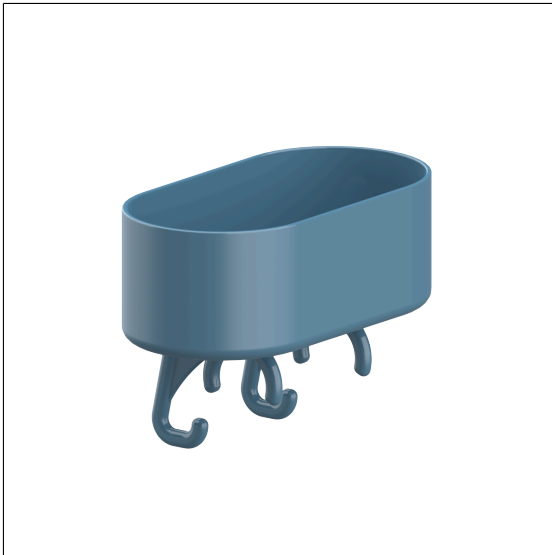

Technical specifications

Product group	0200
Product	Shower box, with clamping device
Length	210 mm
Width	111 mm
Height	145 mm
Storage space	200 cm ³
Material	polyamide
Surface	high gloss
Colour	available in nylon colours

Technical drawing

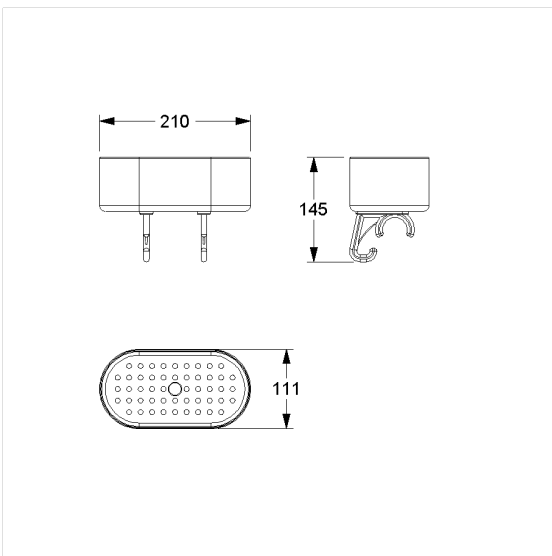

Product description

- for clipping on Inox Care and Nylon Care Shower handrails
- the shower box bottom has a structured non-slip surface as well as a drain hole

