

Care Solutions · Nylon Care Accessories

Nylon Care Toilet roll holder,
retrofittable

Article number: 0449120018

Product image



Technical specifications

Product group	2000
Product	Toilet roll holder, retrofittable
Length	141 mm
Width	39 mm
Height	117 mm
Material	polyamide
Surface	high gloss
Colour	available in nylon colours

Technical drawing

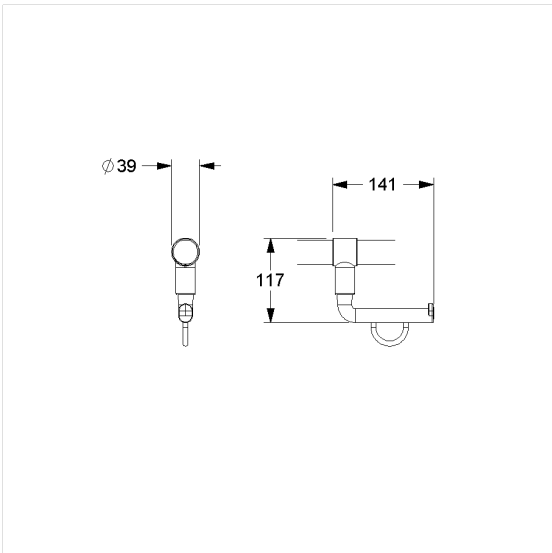

Product description

- Nylon Care - a well-trying and proven product family with a wide range of variants, three product series suiting many different requirements
- for Nylon Care Lift-up support rails and wall-mounted support rails and grab rails
- for take on commercially available paper rolls
- with maintenance-free roll brake
- supplied with fixing material
- not suitable for lift-up support rails with one horizontal rail (0437...) and angled grab rails of Nylon Care 400 series

