

## Care Solutions · Verso Care

Verso Care Grab bar,  
with 3 fixing points

Article number: 3500105015

### Product image



### Technical specifications

Product group	3800
Product	Grab bar, with 3 fixing points
Axle dimension a1	1000 mm
Fixing type	single-point mounting
Fixing points	3 Piece
Diameter	34 mm
Material	polyamide
Surface	high gloss
Colour	available in nylon colours
Version	left and right
Loading	max. 175 kgs

### Technical drawing

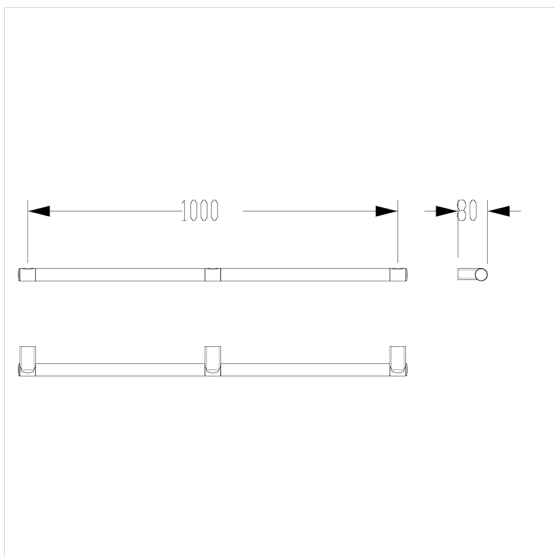

### Product description

- Nylon Care - a well-trying and proven product family with a wide range of variants, three product series suiting many different requirements
- with non-corrosive steel core throughout
- concealed screw fixing
- single-point wall attachment with 3mm tolerance compensation (= ffl 1.5mm) for an easy and safe installation,
- In case of lightweight partition walls a backfill made of min. 30mm hardwood is needed
- produced in accordance with Regulation (EU) 2017/745 on medical devices
- CE-certified
- meets the requirements of German standard DIN 18040 and Austrian standard ÖNORM B 1600
- supplied with stainless steel hexagon head screws  $\varnothing 6 \times 100$  mm according to DIN 571 and dowels

