

Care Solutions

Care operating lever,
retrofitting

Article number: 0466450015

Product image



Technical specifications

Product group	2000
Product	operating lever, retrofitting
Length	15 mm
Width	157 mm
Height	218 mm
Material	stainless steel, material No. 1.4301 (A2, AISI 304), Handle made of polyamide
Surface	brushed finish, Handle high gloss
Colour	available in nylon colours

Technical drawing

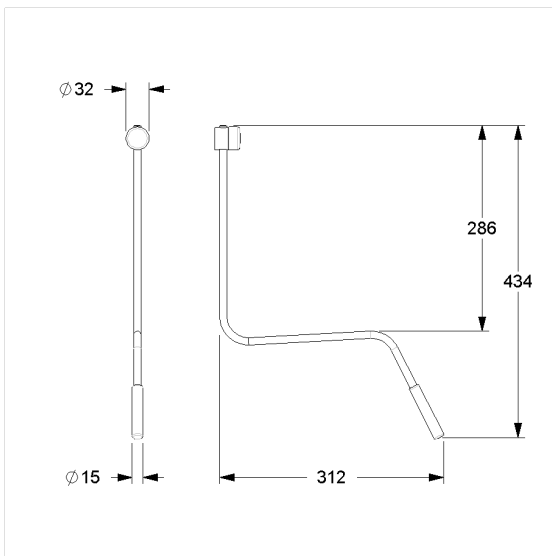

Product description

- lateral tilting with adjustable friction hold
- operating handle to be mounted on the backside of the adjustable mirror, left or right side possible
- suitable for wash basins mounted to walls projecting up to 150mm
- retrofitting for Cavere Care and Nylon Care 400 adjustable mirrors

