

Verso Care Shower head holder

Article number: 3501220015

Product image



Technical specifications

Product group	3800
Product	Shower head holder
Length	115 mm
Width	53 mm
Height	133 mm
Material	polyamide
Surface	high gloss
Colour	available in nylon colours and Red (012)

Technical drawing

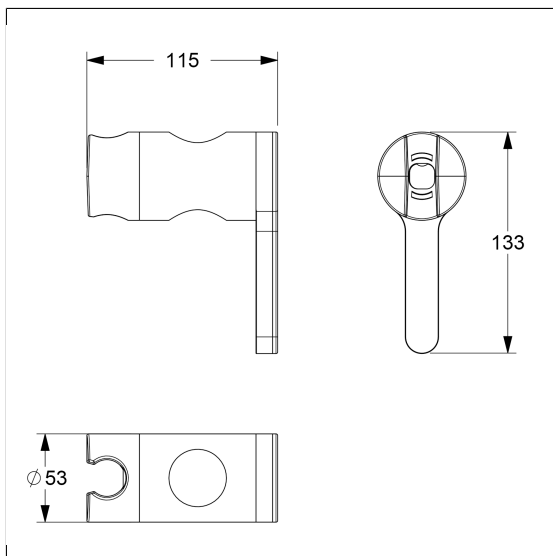

Product description

- Nylon Care - a well-trying and proven product family with a wide range of variants, three product series suiting many different requirements
- for fixing on Verso Care shower rails
- Shower head holder with easy adjustment to any height and angle, self-adjusting clamp maintenance-free
- side-mounted operating handle for one-handed operation by turning
- Shower head holder suitable for various hand shower types

