

Care Solutions · Nylon Partition solutions

Nylon Partition Door Lock,
with distance piece

Article number: 0840080018

Product image



Technical specifications

Product group	2600
Product	Partition Door Lock, with distance piece
Short name	NY.TWR 840.03
Spacer	12 mm
Door thickness	9 - 13 mm
Length	80 mm
Width	85 mm
Height	52 mm
Material	polyamide
Surface	high gloss
Colour	available in nylon colours

Technical drawing

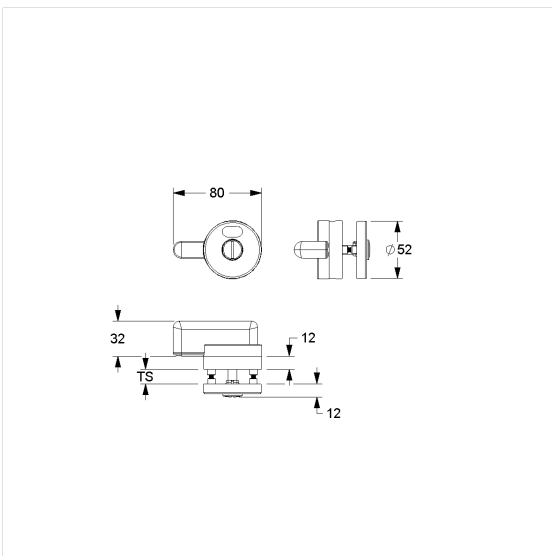

Product description

- Design partition solutions for doors and partitions made of HPL board material
- Suitable for rebated, unrebated and unrebated overlapping doors, depending on the design
- Thumbturn 360° turnable, with 90° snap-in locking
- corrosion protected
- Supplied with 2 M4 countersunk screws
- Available for other door thicknesses on request

