

Care Solutions · Cavere Care Accessories

Cavere Care Double hook

Article number: 7500120095

Product image



Technical specifications

Product group	7010
Product	Double hook
Length	54 mm
Width	37 mm
Height	60 mm
Material	aluminium
Surface	scratch-resistant powder coating with antibacterial protection (except 091 Carbon black)
Colour	available in Cavere colours

Technical drawing

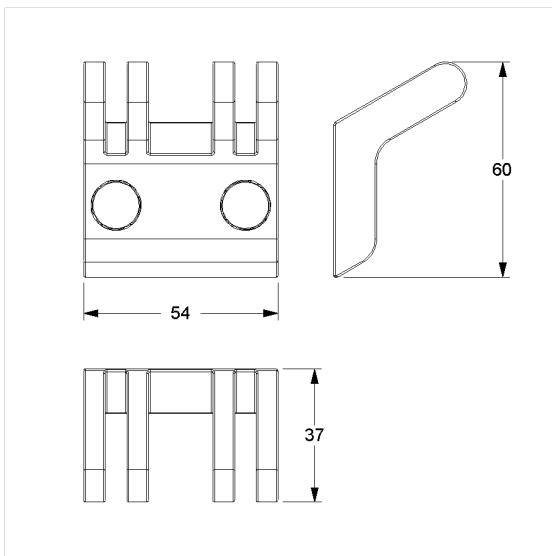

Product description

- Cavere Care as an award-winning product family with excellent design for all requirements
- for hanging and clamping utensils
- for wall mounting
- concealed screw fixing
- supplied with stainless steel Torx screws $\varnothing 5 \times 60$ mm and plugs



Antibac



091 092 093 095 096